

RAVAS

USER MANUAL **iForks-32 (XT)**

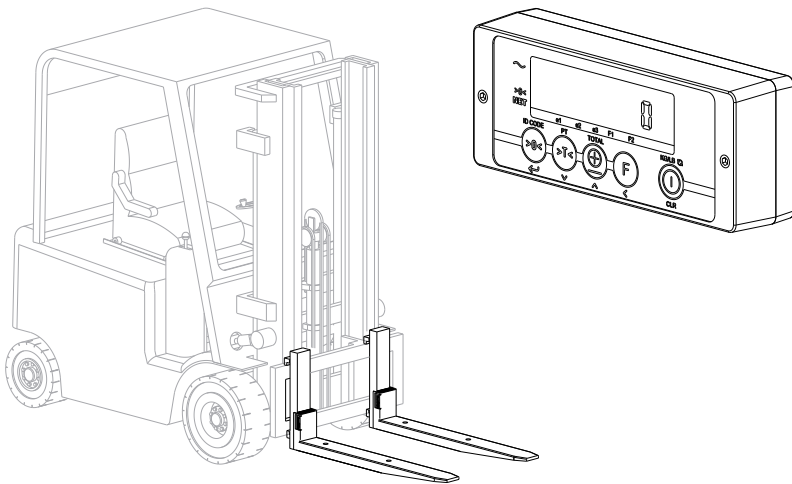

We would like to inform you about the fact that this RAVAS product is 100% recyclable on the basis that the parts are processed and disposed of in the right manner.
More information can be found on our website: www.ravas.com

Rev. 20200305

Printing/Typographical errors and model changes reserved.



PLEASE RETAIN THESE INSTRUCTIONS FOR FUTURE REFERENCE

If you have any queries concerning the duration and terms of the guarantee, please contact your supplier. We would also refer you to our General Sale and Supply Conditions, which are available on request.

The manufacturer accepts no liability for any damage or injury caused by failure to follow these instructions, or from negligent operation or assembly, even if this is not expressly stated in this instruction manual.

In light of our policy of continuous improvement, it is possible that details of the product may differ from those described in this manual. For this reason, these instructions should only be treated as guidelines for the installation of the relevant product. This manual has been compiled with all due care, but the manufacturer cannot be held responsible for any consequences of errors. All rights are reserved and no part of this manual may be reproduced in any way.

Table of Contents

1. Introduction	4
2. Warning & Safety measures	4
2.1 Lithium Ion Battery	5
3. System setup	7
3.1 Installing the iForks-32 (XT)	7
3.2 Locking the iForks-32 (XT)	7
3.3 Installing the indicator	8
3.4 Placing the battery packs in the iForks-32 (XT)	9
3.5 Connecting and switching on the iForks-32 (XT)	10
3.6 Switching off the system	11
4. Changing batteries	12
4.1 Low battery indication iForks-32 (XT)	12
4.2 Changing the battery packs of the iForks-32 (XT)	13
4.3 Charging the rechargeable battery packs	13
4.4 Changing the batteries of the indicator	14
5. Use	15
5.1 Use (accurate weighing)	15
5.2 Level correction (option)	16
5.3 Bluetooth communication	17
5.3.1 Establish Bluetooth communication and weigh!	17
5.3.2 Auto-reconnect function	18
5.4 Auto shut-off indicator	19
5.5 Auto shut-off iForks-32 (XT)	20
5.6 Indicator functions	21
5.7 Error messages	23
5.8 Net / Tare / Gross weight	24
5.8.1 Net weighing: automatic tare	24
5.8.2 Net weighing: manual tare (PT)	26
5.9 Adding & reset	29
5.10 Changing the time and date (on the printout)	31
5.11 LB-KG switch	33
5.12 User settings	34
5.12.1 Overview power save settings (auto shut-off)	36
5.13 Supervisor menu	37
5.14 Relay function	38
5.15 Alibi memory	39
6. RAVAS WeightsApp	43

1. Introduction

This manual describes the installation and use of the **iForks-32 (XT)**. Read this manual carefully. The installer must be informed of the contents of this manual. Always do things in the correct order. This manual should be kept on a safe and dry place. In case of damage or loss the user may request a new copy of the manual from RAVAS.

2. Warning & Safety measures

When using the **iForks-32 (XT)**, please observe carefully the instructions and guidelines contained in this manual. Always perform each step in sequence. If any of the instructions are not clear, please contact RAVAS.



- All safety regulations that apply to the truck remain valid and unchanged;
- No weighing operations are allowed if any persons or objects are in the vicinity; around, under or close to the load;
- RAVAS is not responsible for any physical harm done to the operator because of the presence of the indicator in the cabin;
- Any modifications done to the system must be approved in writing by the supplier, prior to any work being completed;
- It is the sole responsibility of the purchaser to train their own employees in the proper use and maintenance of this equipment;
- Do not operate this unit unless you have been fully trained in its capabilities;
- Check the accuracy of the scale on a regular basis to prevent faulty readings;
- Only trained and authorized personnel are allowed to service the scale;
- Always follow the operating, maintenance and repair instructions of this truck and ask the supplier when in doubt;
- RAVAS is not responsible for errors that occur due to incorrect weightings or inaccurate scales.

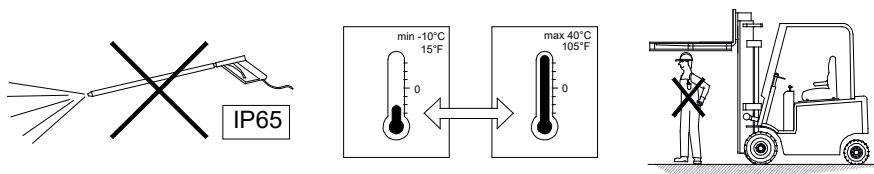

Should you have any further questions after reading this manual then you can contact us at:

RAVAS USA, LLC

1500 Enterprise Parkway

Twinsburg, OH 44087

Phone number: +1 (330) 425-3092

www.ravasusa.com

Changes reserved

2.1 Lithium Ion Battery

Important Safety Information



DANGER

- Use the specific Li-ion charger and observe the specified charging conditions when charging the battery.
- Avoid influences of high temperature and keep away from fire.
- Do not deform, modify or disassemble the battery.
- Do not connect the (+) and (-) terminals with metal objects.
- Do not put the battery in (sea) water.
- Do not throw with the battery to avoid strong shocks.



WARNING

- When a battery leaks, the battery should directly be wrapped up properly and treated as recyclable resource.
- When, due to leaking from the battery, liquid gets into your eyes, immediately clean the affected area with water without rubbing your eyes, and seek medical advice immediately.
- The charging of the battery will be stopped automatically. When due to what cause the battery is not fully charged after 8 hours (LED of the charger doesn't become green), immediately unplug the battery from the holder to stop charging. Battery or charger does not work properly, exchange battery or charger.
- Storing and/or using the battery outside the given temperature range may have a negative effect on the lifetime and/or the performance of the battery.
- Do not longer use a battery with leakages, deformation or when any other abnormalities occur.
- Battery should be charged in a dry surrounding.



WARNING

Charging can be carried out at any time regardless of the amount of charge remaining, but you should fully charge the battery at the following moments:

- **The battery is not fully charged at the time of delivery!** The battery can be used after fully charging with the specific Li-ion charger. The LED on the battery charger will become green when fully charged. Note: Before using the weighing system, be sure that the battery is fully charged.
- After the battery has become completely empty. An empty battery will break (loss of capacity) when not directly fully charged.

Specifications

Battery	Operating temperature range
Nominal voltage / capacity	BA-3.7V-5.2A: 5.2 Ah (used for iForks) BA-14.8V-5A: 5 Ah (used for hand pallet trucks)
Operating temperature range	During use: -10°C - +50°C During charging: 0°C - +40°C

Operation

- **Normal charging**
 - Charging takes up to 6-7 hours for a full charge (a partially discharged battery will be fully charged sooner).
 - When the battery is fully charged, charger stops automatically.
 - After charging, the battery should be taken out of the charger.
- **Storing the battery**
 - When the weighing system is not used for a longer period, make sure the battery has approximately 70% of the battery capacity remaining. Take care not to let the battery become completely empty by charging it every 6 months.
 - Store the battery separated from the weighing system in an indoor place (approx. +10°C - +20°C) where it is not exposed to direct sunlight or rain.
- **Battery life**

The battery is a consumable item. The battery will gradually lose its capacity for charging after repeated use and after time has passed. If the operating time that the battery can be used becomes shorter and shorter, it has probably reached the end of its life.

Note: For replacement or additional battery pack, contact your distributor.
- **About used batteries**

Lithium ion batteries are recyclable, valuable resources. For recycling of broken or used batteries, follow the local guidelines in your country. If you are not sure, please send back to the distributor for proper way of recycling.



Disposal information for countries outside the European Union

This symbol is only valid within the European Union. Follow local regulations when disposing used batteries. If you are not sure, consult the place of purchase or a RAVAS dealer.



3. System setup

3.1 Installing the **iForks-32 (XT)**

The standard forks must be taken off the carriage plate. The **iForks-32 (XT)** are placed on the carriage plate.

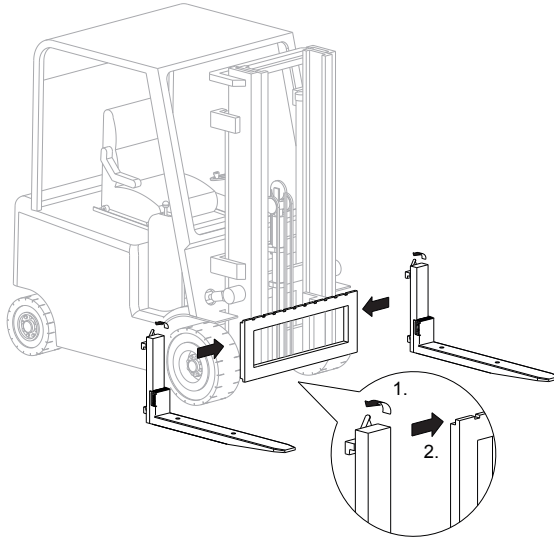

3.2 Locking the **iForks-32 (XT)**

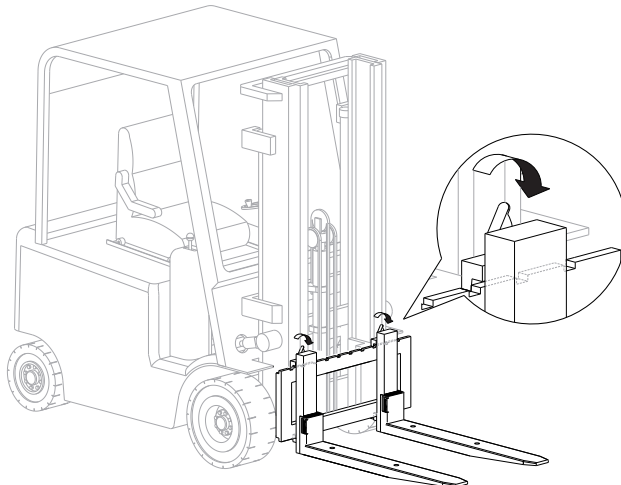

3.3 Installing the indicator

Find a suitable position for the indicator:

1. at the cabin's roof.
2. on the right side of the cabin, mounted onto a side-rail.
3. on the dashboard.

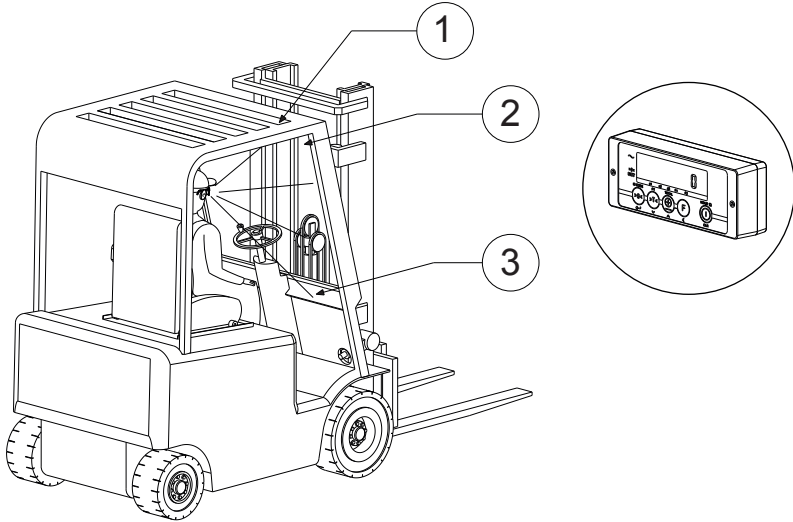

Installation of the indicator bracket & support.

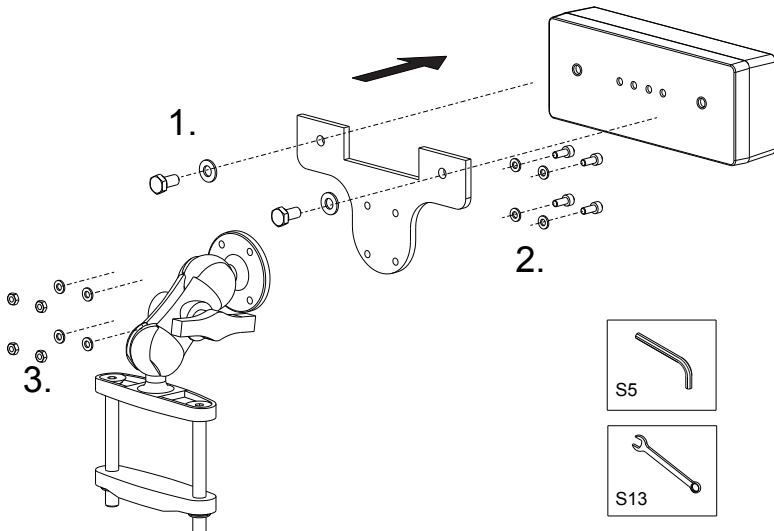

3.4 Placing the battery packs in the **iForks-32 (XT)**

1. Push the red locking clips down to unlock the battery holders.
2. Open the battery holders of both forks.
3. Position the battery packs in the battery holders of both forks until the red locking clip shifts up again.
4. Close the battery holders of both forks until you hear a “click”.

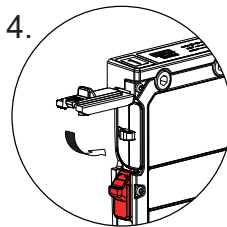
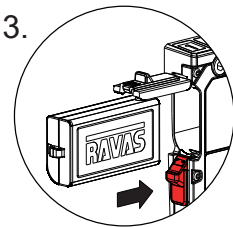
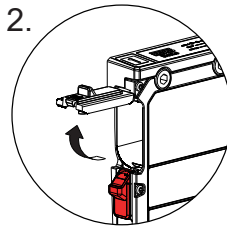
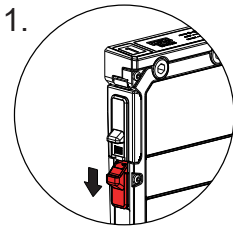
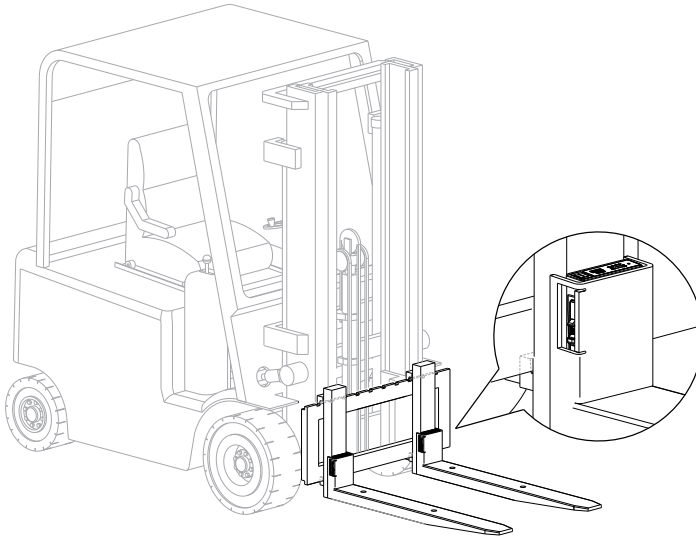

3.5 Connecting and switching on the **iForks-32 (XT)**

1

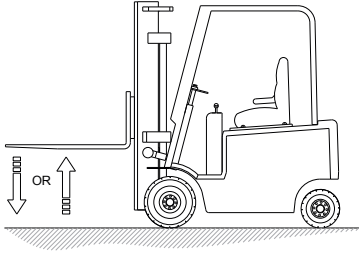

Switch on the **iForks-32 (XT)**:
Move the **iForks-32 (XT)** quickly in upwards
or downwards direction.

2

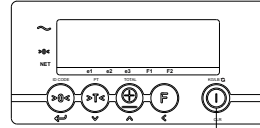

Start up the
indicator. Press
the on/off key.



3

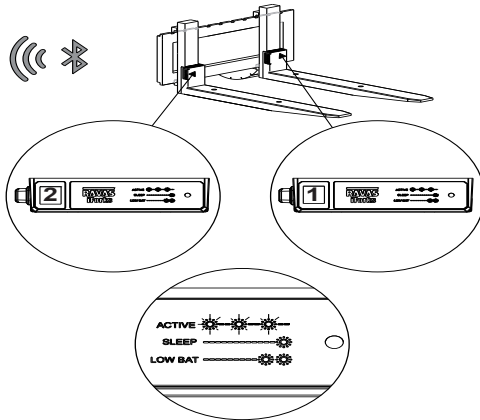
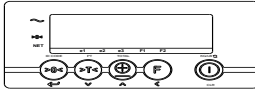

The Bluetooth link between the indicator and
the forks will connect automatically.

The **iForks** are “ACTIVE” when the blue LEDs
on both **iForks** (1 & 2) flash repeatedly.

After 5 seconds all electronics are warmed up and you can start weighing.

3.6 Switching off the system

1

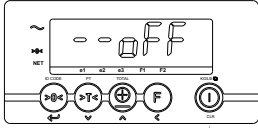

Switch off the indicator by pressing the on/off key for 3 seconds.



2

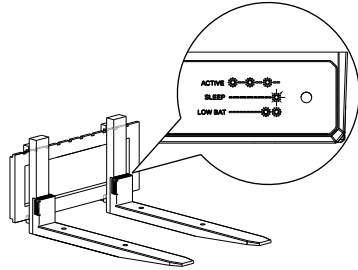

Both forks will switch off automatically.

The blue LED's "SLEEP" on both **iForks** (1 & 2) will start blinking automatically.

4. Changing batteries

4.1 Low battery indication **iForks-32 (XT)**

Exchangeable battery packs supply power to the **iForks-32 (XT)**.

When the voltage level of the battery packs is running low, the low battery indicator will light up and the pointer of the relating fork - "F1", "F2" or both - will start blinking in the display. The blue LED (LOW BATTERY) on the relating fork will start blinking very slowly (twice every 10 sec). The **iForks-32 (XT)** will switch off automatically after 10 minutes.

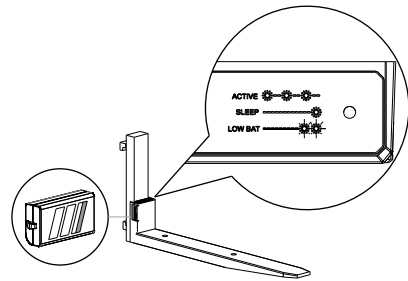
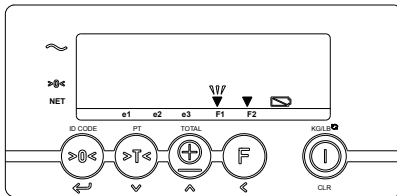

FUNCTIONALITY BLUE LED

DURING POWERING ON	ON for 5 sec.
FULL BATTERY	Blink time interval
Working mode	Once every 1,5 sec.
Sleep mode	Once every 12 sec.
LOW BATTERY	
Working mode	Twice every 10 sec.
Sleep mode	Twice every 10 sec.

4.2 Changing the battery packs of the iForks-32 (XT)

Take out both battery packs.

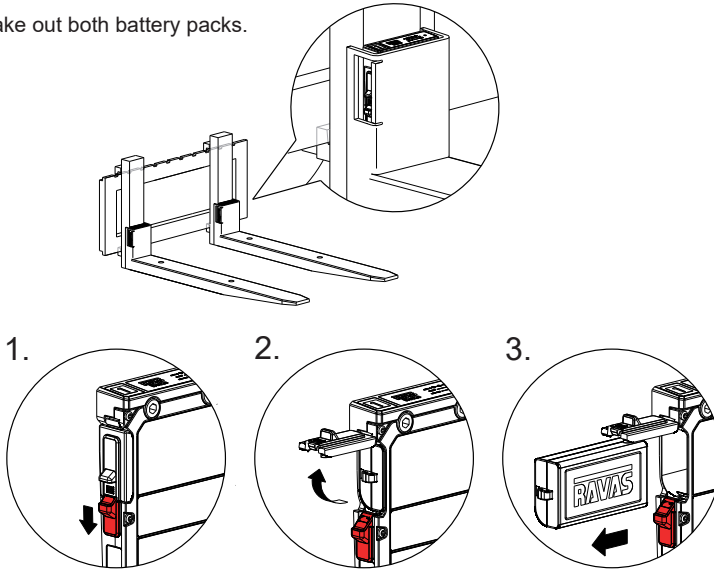

4.3 Charging the rechargeable battery packs

The system is equipped with rechargeable battery packs and a smart charger. After charging for at least 8 hours, the charger will shut off when the battery packs are completely full. The red LED on the adapter will change to green once the batteries are fully charged.

NOTE: It is not necessary to charge both batteries simultaneously. If one battery is charged at a time, the charging time will be shorter.

First position the battery packs inside the charger module, then plug the adapters into the mains voltage.

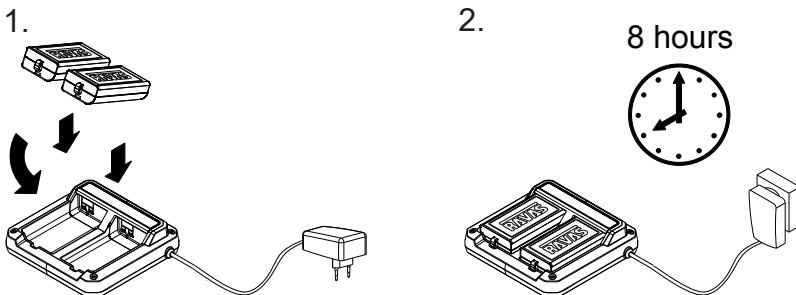

4.4 Changing the batteries of the indicator

As standard, the new indicator is equipped with 4 AA batteries.

1

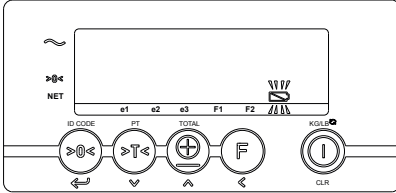

Replace batteries as soon as the low battery indicator starts blinking.

2

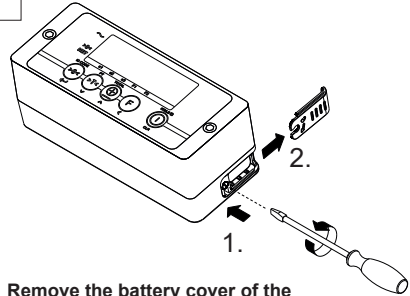

Remove the battery cover of the indicator housing by turning the screw counter-clockwise.

3

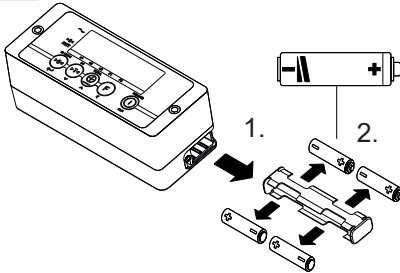

Remove the battery holder and remove the empty batteries.

4

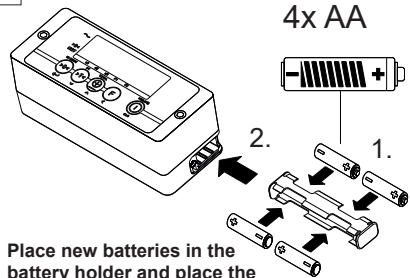

Place new batteries in the battery holder and place the battery holder in the housing. Be sure the batteries are positioned correctly. Check for the polarity!

5

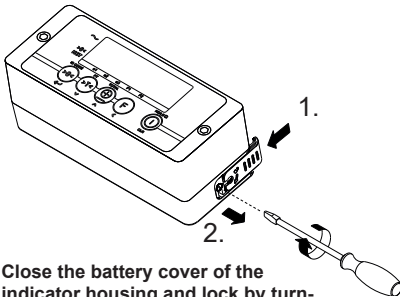

Close the battery cover of the indicator housing and lock by turning the screw clockwise.

5. Use

5.1 Use (accurate weighing)

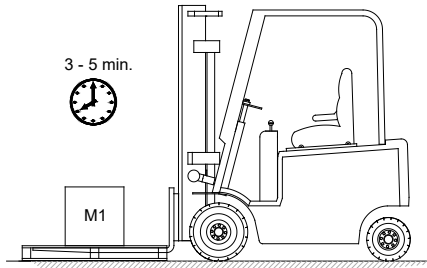

After 3 to 5 minutes the load cells have reached the operational temperature. Don't lift loads before the zero-point correction has been executed.

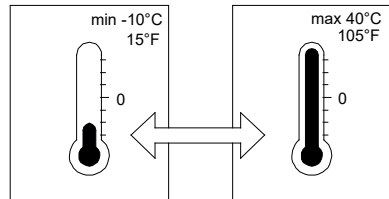
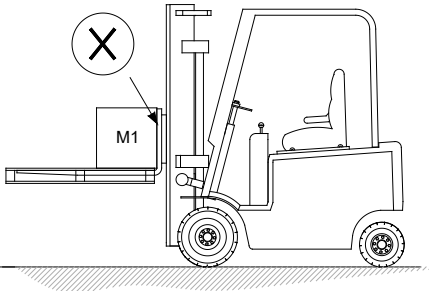
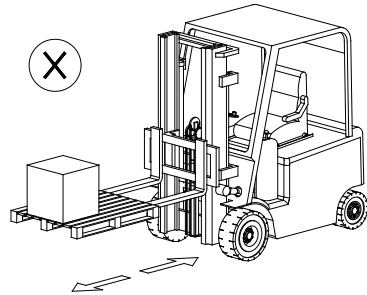
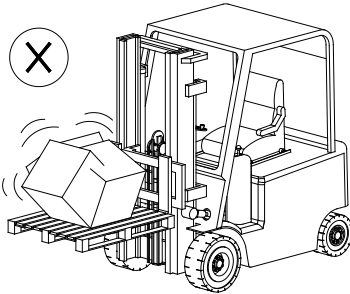
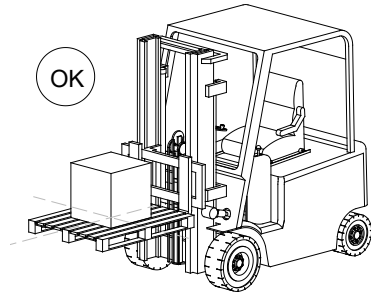

5.1.1 Check the zero reading before each weighing

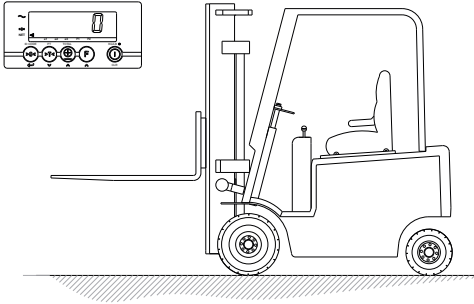

Check the zero reading before each weighing!

Before each weighing it is necessary to check whether the system is unloaded and free.

If the indicator does not determine the zero point automatically, it must be done manually using the >0< key.

5.2 Level correction

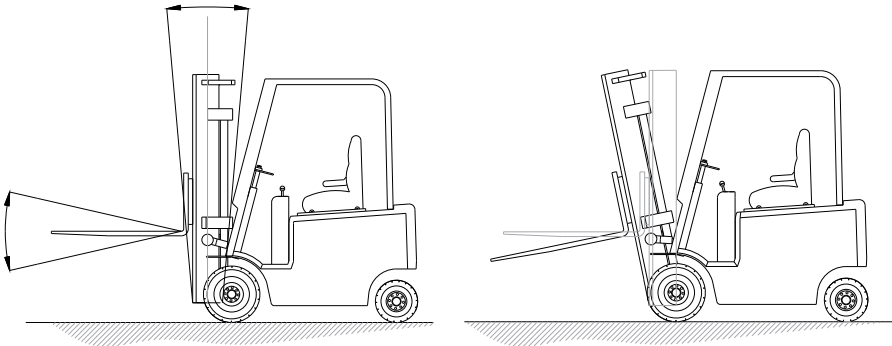

Legal for trade:

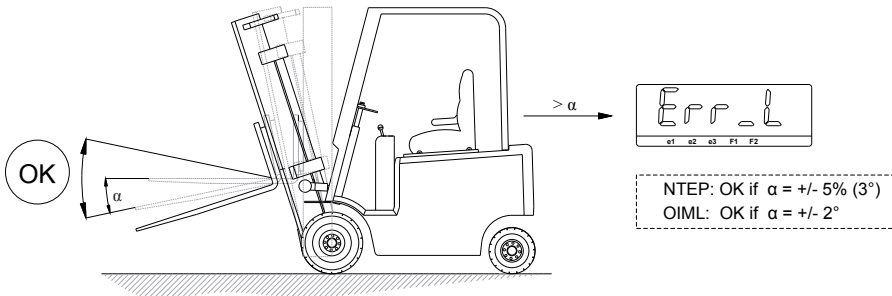

5.3 Bluetooth communication

5.3.1 Establish Bluetooth communication and weigh!

1

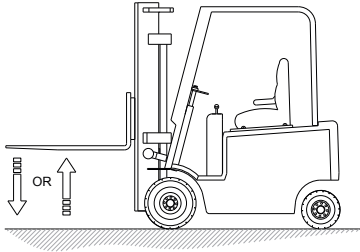

Switch on the **iForks-32 (XT)**:
Move the **iForks-32 (XT)** quickly in upwards
or downwards direction.

2

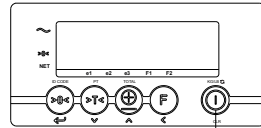

Start up the
indicator. Press
the on/off key.

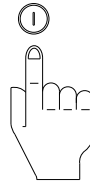

3

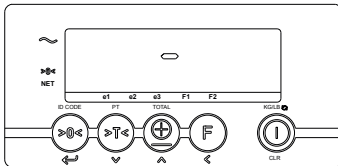

5 sec.



4

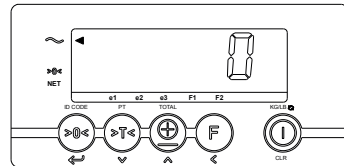

Before each weighing: check the zero point!

*Before each weighing it is necessary to check
whether the system is unloaded and free.
If the indicator does not determine the zero point
automatically, it must be done manually using
the >0< key.*

5

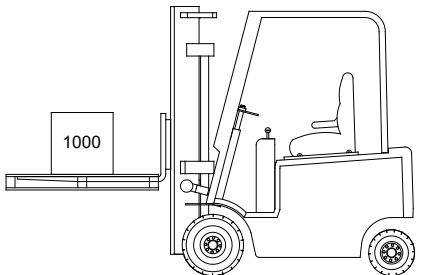

System is ready to weigh.

6

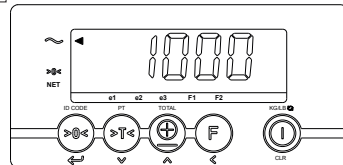

**Before the next weighing,
check the zero point again.**

5.3.2 Auto-reconnect function

1

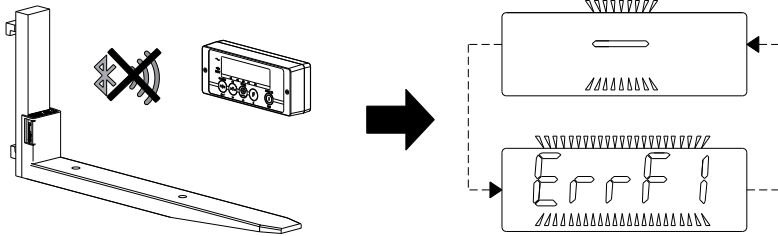

If the Bluetooth link between the indicator and forks is lost, the indicator will show this error message.

2

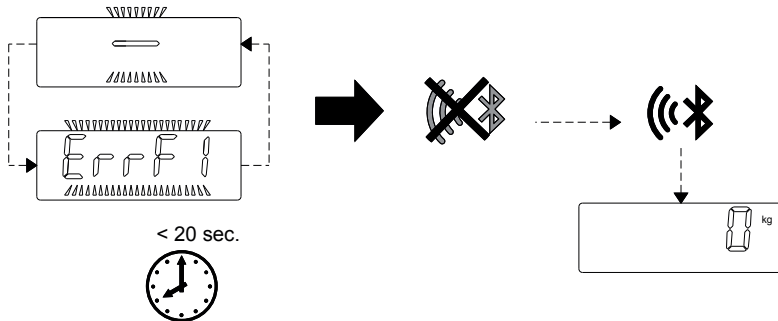

Just wait for maximum 20 seconds.

The Bluetooth link will re-connect automatically.

3

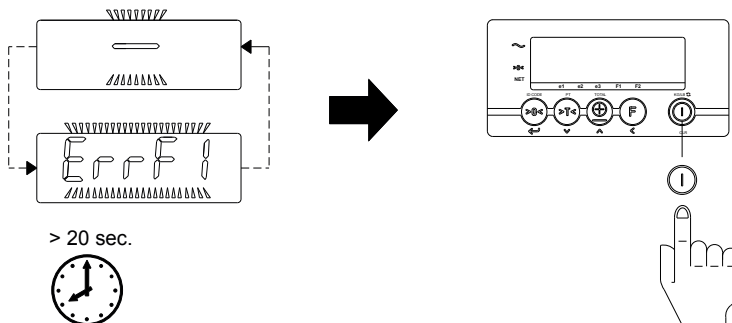

If the Bluetooth link does not re-connect, remove and replace the batteries of the forks, and then restart the indicator.

5.4 Auto shut-off indicator

1

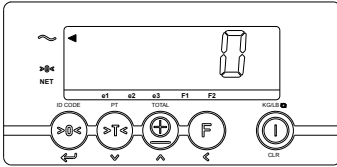

2 min. No action !



2

20 sec.

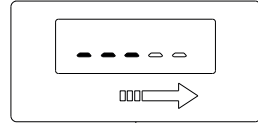

Countdown starts:
Press any key
during countdown to
cancel auto-shut-off
and go back to the
weighing mode.



3

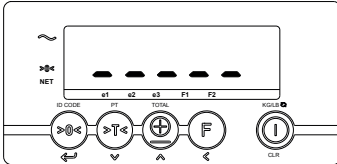

4

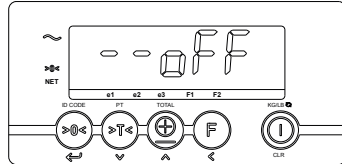

5

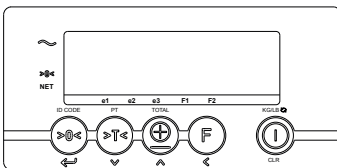

Indicator off

6

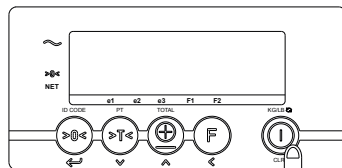

To activate the indicator,
press the on/off key.

7

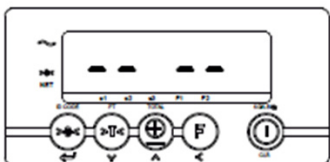

8

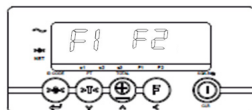
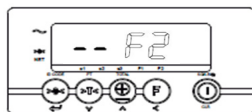

The display automatically returns to its normal weighing mode.

5.5 Auto shut-off iForks-32 (XT)

1

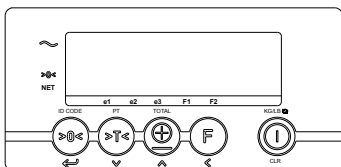

2 hour

No weighing!



2

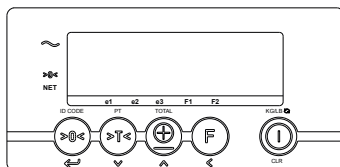

-iForks-32 (XT) off
-Indicator off

3

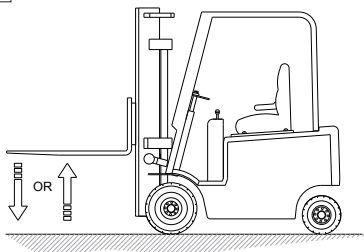

Switch on the **iForks-32 (XT)**:
Move the **iForks-32 (XT)** quickly in upwards
or downwards direction.

4

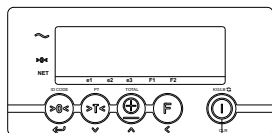

Restart the indicator:
Press the on/off key.



5.6 Indicator functions

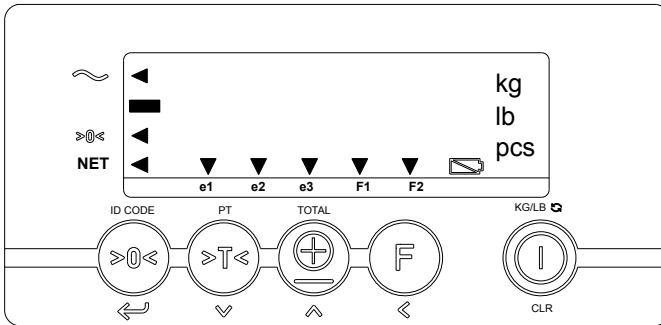

the weighing system (including load) is stable



the weight shown is negative

ZERO



the weight shown is within the zero range

NET



the display is showing the net weight

e1



displayed weight is in range 1 (option multi range)

e2



displayed weight is in range 2 (option multi range)

e3



displayed weight is in range 3 (option multi range)

F1 + 



Fork 1 Low battery

F2 + 



Fork 2 Low battery

kg

displayed weight is in kilograms

lb





displayed weight is in pounds



low bat indicator

Key functions

Each key has 2 operational and one entry function.

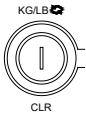
Standard function (short key press)	Key	Special function (long key press)	Value entering function (entry mode)
Zero setting		code entry	enter
automatic tare		pre-set tare	decrease the value of the digit flashing
print weight and add to the total		check subtotal and print/reset total	increase the value of the digit flashing
start special function if active		no function	shift to the next digit on the left
On switch And change to lb and kg		Off switch	clear entry



Important

Operation of a key is not accepted unless the weighing system is stable (and the "load stable" pointer lights up). This means that the indicator only executes commands with a stable load.

For a detailed description of the function CODE ENTRY check our operational manual Indicator 3200 at www.MyRAVAS.com.

5.7 Error messages

ERROR MESSAGES

Display	Meaning	Out of error mode
Err01	Load cell signal is unstable	Automatic
Err02	Overload on full scale	Automatic after removing weight
Err03	Gross negative. This action is not allowed	Automatic
Err04	Out of zero range	Press any key
Err06	Input signal too high	Automatic after correcting input
Err08	Calibration out of range (negative)	Automatic
Err09	Calibration out of range (signal too low)	Automatic
Err10	Calibration count 2nd (3rd) point lower than count 1st (2nd) point	Automatic
Err14	Setpoint value 2 < setpoint value 1. This is not allowed	Automatic
CAL-J	Legal for trade version: action not allowed	When action is intended, remove jumper JP1 (attention: after this action a complete new calibration and stamping of the system is necessary)
Err98	Calibration point must be higher than previous one	Automatic
Err99	Action only allowed in start-up units	Automatic
ErrF1	Problem with fork 1 (no communication)	Restart indicator. Restart forks & indicator
ErrF2	Problem with fork 2 (no communication)	Restart indicator. Restart forks & indicator
----	Loadcell signal negative	Lift up the forks from the ground
Err_L	Forks are out of level (only legal-for-trade version)	Put the forks into horizontal position
	Battery of indicator is empty	Replace the 4 AA batteries
 +F1 ▼	Battery of fork 1 is empty	Replace the D-cells in both battery packs or charge both battery packs
 +F2 ▼	Battery of fork 2 is empty	Replace the D-cells in both battery packs or charge both battery packs
tiP	too large load on tip of forks (only legal for trade version)	change load placement
SidE	too large load on one fork (only legal for trade version)	change load placement
OimL	action not allowed (only legal for trade version)	automatic
ntEP	action not allowed (only legal for trade version)	automatic
SCALL	audit trail no out of range	Contact RAVAS Service department
Er_F1	too few samples for measurement	Wait for improvement of the bluetooth connection (try moving the mast to lower position)
Er_F2	too few samples for measurement	Wait for improvement of the bluetooth connection (try moving the mast to lower position)
ESoFt	Wrong combination of firmwares	Contact your dealer
EConF	P96 not set	Contact your dealer

DISPLAY MESSAGES

Display	Meaning	
BlfF1	Successful Bluetooth link with fork 1	No error
BlfF2	Successful Bluetooth link with fork 2	No error

5.8 Net / Tare / Gross weight

EXPLANATION: Net(1) + Tare(2) = Gross(3)

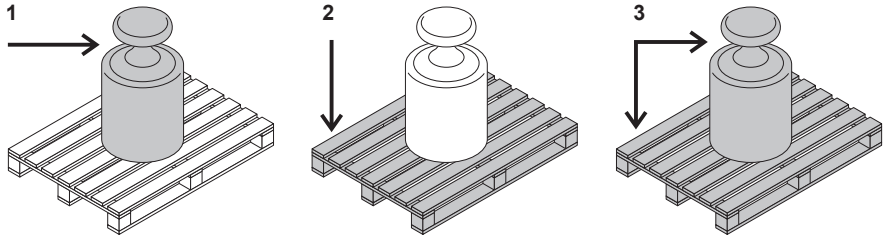

5.8.1 Net weighing: automatic tare

<p>1</p>	<p>2</p>
<p>3</p>	<p>4</p> <p>The indicator is set to zero. The "NET" pointer shows that the tare weight is activated.</p>

5

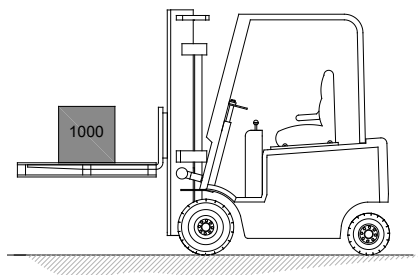

6

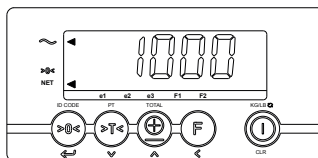

The display shows the net value of the weighed load.

7

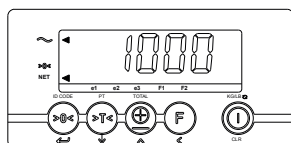

8



The gross weight is displayed again.

9

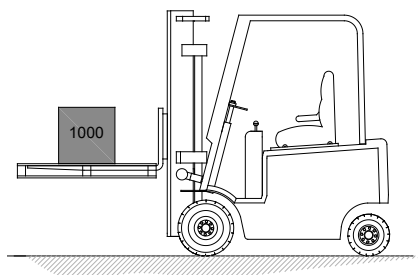

NOTE: for NTEP iForks-32 (XT) the tare will be erased automatically when the weight returns to gross zero! For the next weighing the tare must be activated again.

5.8.2 Net weighing: manual tare (PT)

1

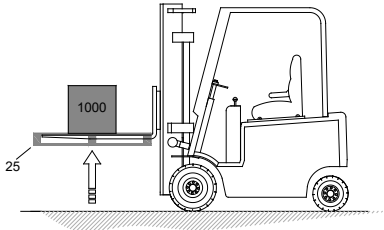

2

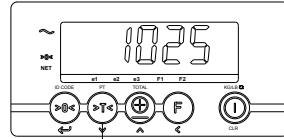

3 sec.



Press the
>T< key for 3
seconds.

3

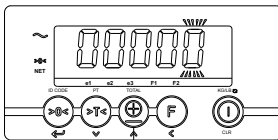

5x



Press the up
or down key
until the
desired value
is reached.

4

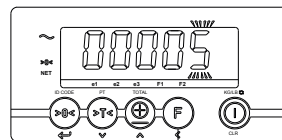

1x



5

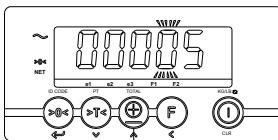

2x



Press the up
or down key
until the
desired value
is reached.

6

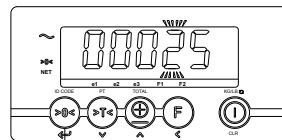

Press ENTER
to activate the
tare weight.

7

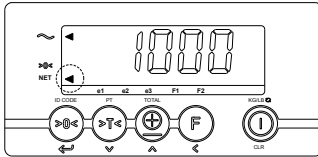

The 'NET' pointer lights up.

8

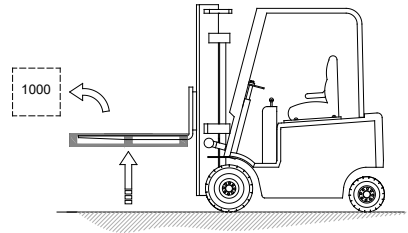

9

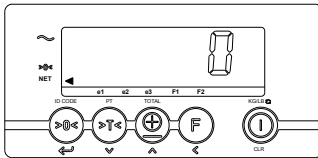

10

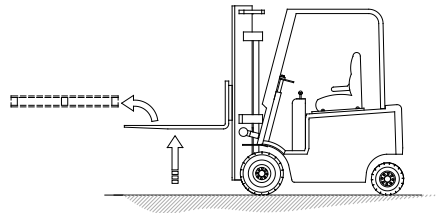

11

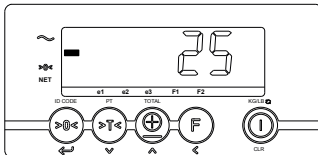

When the **iForks-32 (XT)** are completely unloaded, the tare value is displayed negatively.

NOTE: for NTEP iForks-32 (XT) the tare will be erased automatically when the weight returns to gross zero! For the next weighing the tare must be activated again.

12

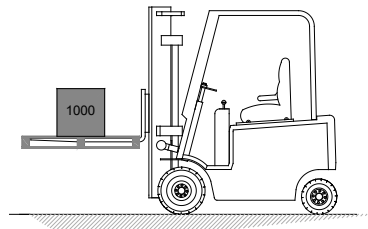

13

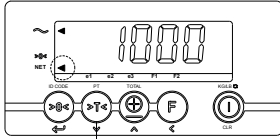

14

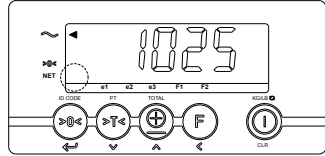

The gross weight is displayed again.

NOTE: The last used preset tare value will remain in the preset tare memory. For re-using preset tare value hold the >T< key for 3 seconds then press Enter.

5.9 Adding & reset

1

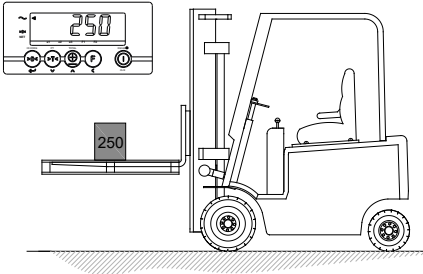

2

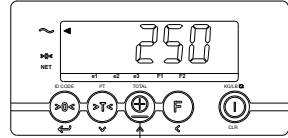

Press the **TOTAL** key to add the weight load to the total weight.

If a printer is installed, a printout will be made. The gross, net and tare weights are printed.



3

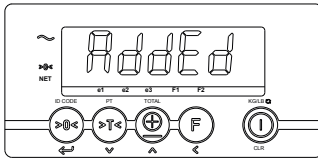

4

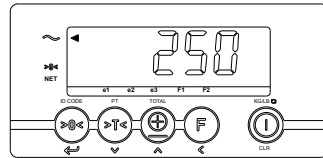

The display returns to the weighing mode automatically.

5

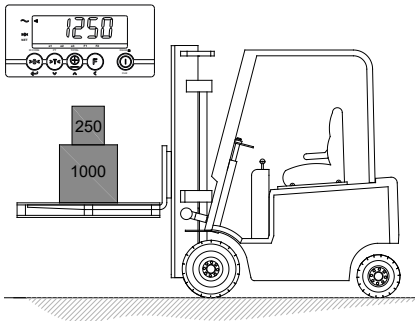

6

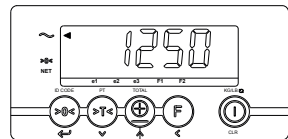

Press the **TOTAL** key to add the load weight to the total weight.

If a printer is installed, a printout will be made. The gross, net and tare weights are printed.



7

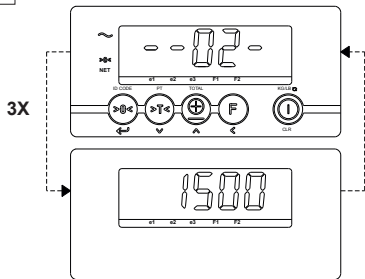

8

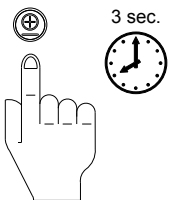
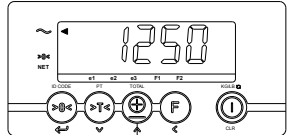

The subtotal can be checked by pressing the TOTAL key for 3 sec.

9

3 sec.

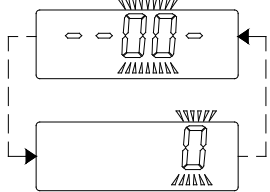
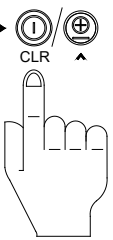
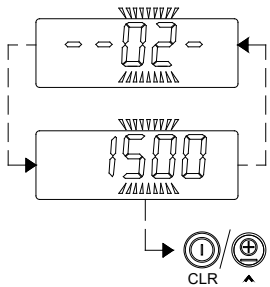
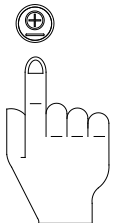

= RESET TOTAL & PRINT



= RESET TOTAL

NOTE: In case the total is not manually used or reset, the system will do this automatically as soon as the total number has reached 99 or as soon as the total weight has reached a value of 99999 kg.

5.10 Changing the time and date (on the printout)

1

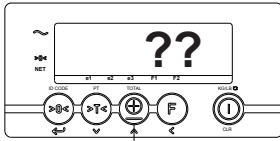

The user menu can be entered by pressing the TOTAL key for 10 sec.

2

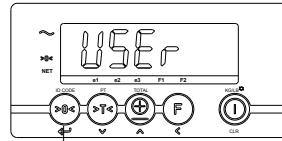

Press enter to Select.

3

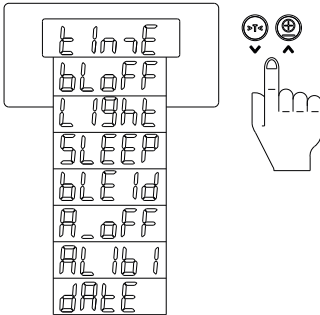

Select 'TIME' in the user menu to change the time.

4

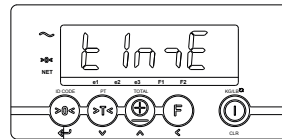

Press enter to change the time.

5

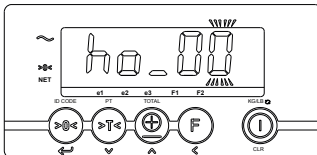

The display will show 'ho_00' or the previous hour time setting

6

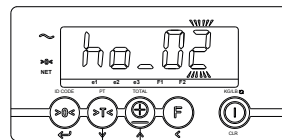

Press the up / down key until the desired value is reached.

7

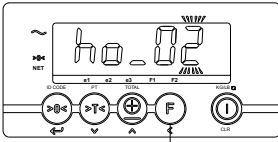

Press < to change the next digit.



8

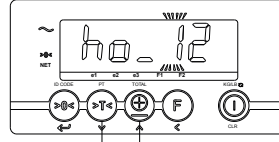

Press the up / down key until the desired value is reached.



9

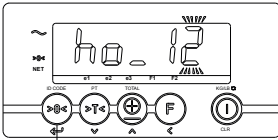

To accept the new value press enter.

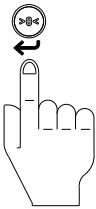

10

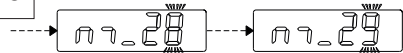

Repeat the procedure to accept or change:
- the minute setting 'm_00'



11

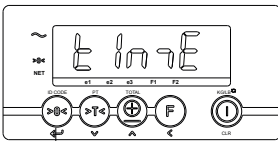

3 sec.



To accept the new setting press enter for 3 sec.

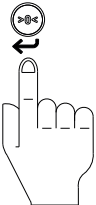

12

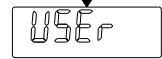
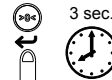
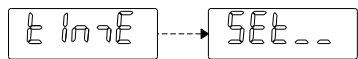

Back to weigh mode.



5.11 Print out (option)

If the weighing system has been equipped with a printer, obtained and entered weighing data can be printed. Date and time are only printed out with the option board installed.

In the printout a gross weight is indicated with the letters "B/G" and a net weight with the letter "N". A manually entered tare weight will also be printed and is indicated with the letters "PT". The total weight is shown with the letters "TOT".

Standard printout
without code

B/G	1234.5	lb.
T	34.5	lb.
N	1200.0	lb.
*1		
Nr.	1	
10/07/03	17:45	

Standard printout
with code

CODE	12345	
B/G	1234.5	lb.
T	34.5	lb.
N	1200.0	lb.
*1		
Nr.	1	
10/07/03	17:45	

Total printout (always without code)

Tot. B/G	1234.5	lb.
Tot. T	34.5	lb.
Tot. N	1200.0	lb.
*1		
Tot. Nr.	999	
10/07/03	17:45	

*1 Note: in case of a legal for trade unit, the alibi number will be printed here.

5.12 KG- LB switch

1

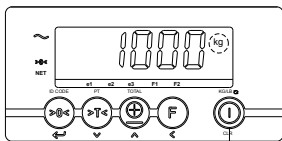

2

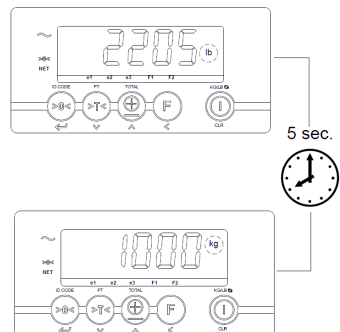

5.13 User settings

1

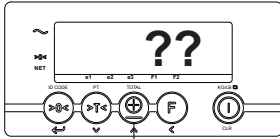

10 sec.



The user menu can be entered by pressing the TOTAL key for 10 sec.



2

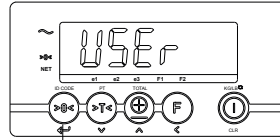

Press enter to Select.



3

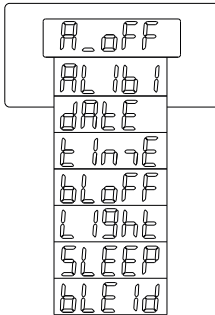

These user settings can be changed if desired. See next pages.

a

▶ EXIT & SAVE



3 sec.

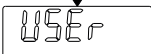

Back to weigh mode.



b

▶ EXIT WITHOUT SAVING

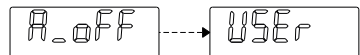

Back to weigh mode.



Set the auto shut-off time indicator (delay time in minutes)

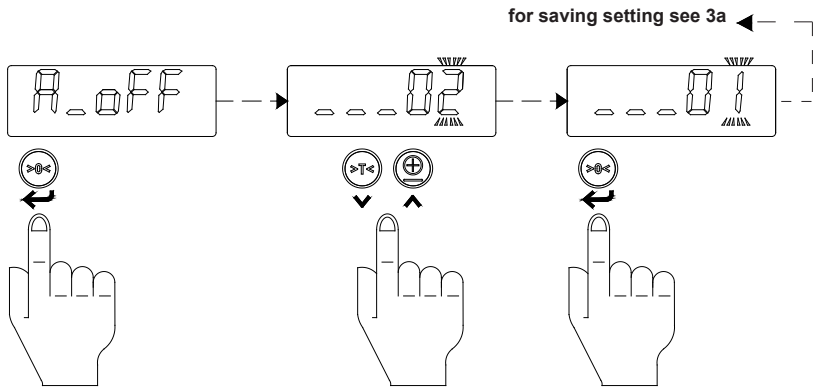



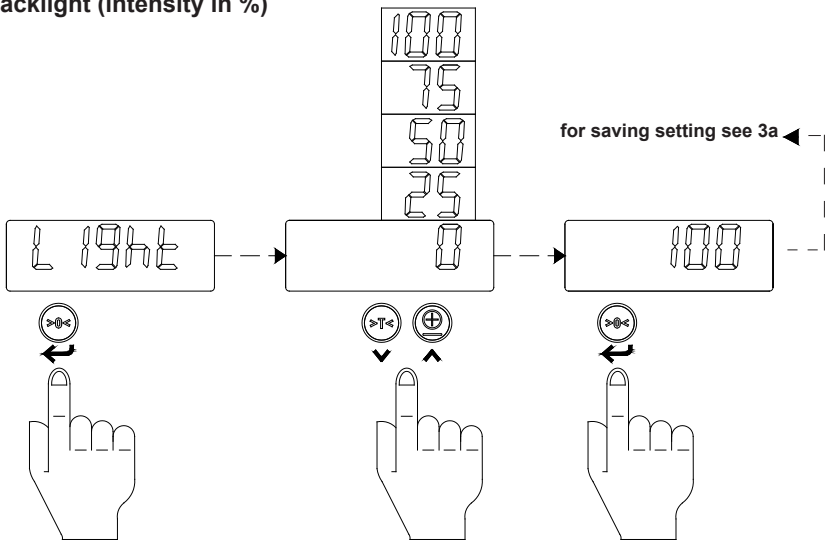



Set backlight (intensity in %)



5.13.1 Overview power save settings (auto shut-off)

Overview of Auto shut-off and Sleep settings. The settings mentioned below are the standard settings and advised by RAVAS for optimal use. These settings can be changed in the user menu, as described above.

Auto Shut-off & Sleep Settings									
		RPW-EL 320 6v	RPW-EL 320 truck supply	RPW-EL 320 auto on			RAVAS 320	RAVAS 320 Li	
Options -> WiFi / RS / Bluetooth	SLEEP	not possible	0	0	Options -> WiFi / RS / Bluetooth	SLEEP	0	0	
	A_OFF	not possible	0	0		A_OFF	30	30	
		P60	6	FLT	FLT	P60	12	14.8	
No options / Printer 6v	SLEEP	2	30	0	No options	SLEEP	20	20	
	A_OFF	5	0	0		A_OFF	30	30	
									
		iForks 6v	iForks truck supply	iForks auto on			RWV-C truck supply	RWV-C auto on	
Options -> WiFi / RS / Bluetooth	SLEEP	not possible	0	0	Options -> WiFi / RS / Bluetooth	SLEEP	0	0	
	A_OFF	not possible	0	0		A_OFF	0	0	
		P60	6	FLT	FLT	P60	FLT	FLT	
No options / Printer 6v	SLEEP	2	30	0	No options	SLEEP	0	0	
	A_OFF	5	0	0		A_OFF	0	0	
									
		RPW-ST 320 6v	RPW-ST 320 truck supply	RPW-ST 320 auto on	RPW-ST- BLE 320 6v (no printer)	RPW-ST- BLE 320 truck supply	RPW-ST- BLE 320 auto on		
Options -> WiFi / RS / Bluetooth	SLEEP	not possible	0	0	not possible	0	0		
	A_OFF	not possible	0	0	not possible	0	0		
		P60	6	FLT	FLT	6	FLT	FLT	
No options / Printer 6v	SLEEP	2	30	0	2	30	0		
	A_OFF	5	0	0	5	0	0		
									

5.14 Supervisor menu (password protected *)

1

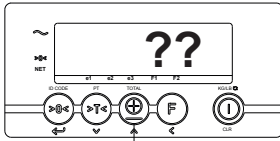

The user menu can be entered by pressing the TOTAL key for 10 sec.

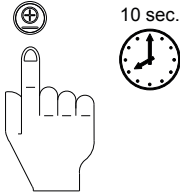

2

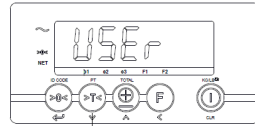

Press to change to Supervisor menu.



3

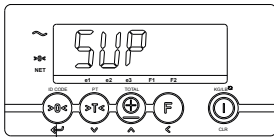

Press enter to Select.



4

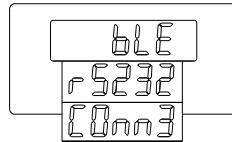

Select to change the setting.



5

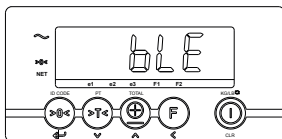

Press enter to Select.



6

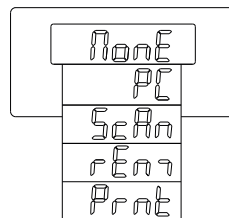

Select to change the setting.



7

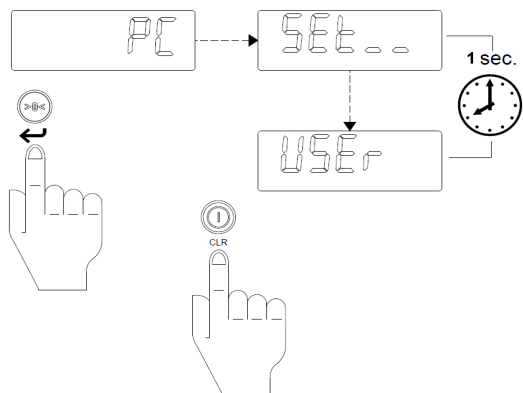

*1 The Supervisor menu is password protected since version 1.01. Earlier versions of the software are not password protected. Please contact RAVAS Service department for the password.

5.15 Relay function - optional

The 3200 indicator has the possibility to setup limit values for relay settings. The different options for relay settings are:

- overload on gross weight
- overload on net weight
- dosing / filling with manual tare & start
- dosing / filling with automatic tare & start

The setup and the activation of the relay settings are explained in the service manual.

5.16 Alibi Memory

The indicator 3200 has the possibility of an alibi memory. The alibi memory will only be used when parameter 13 is set for OIML or NTEP. If parameter 13 is set for 'NONE' the alibi memory will remain unused.

The indicator stores every weighing in its alibi memory and adds a unique number to it. If the alibi memory is activated it will affect the RDC protocol, the PC protocol or the Printer protocol depending on the setting of parameters in the supervisor menu.

The data stored in the alibi memory are:

1. Date > this is the date in format dd\mm\yy (EU) or mm\dd\yy (US).
2. Time > this is the time in format hh:mm.
3. Gross weight > this number always consists of 5 digits, a possible decimal point (as part of the 5 digits), the unit (kg or lb) and the positive or negative sign.
For example: +0233.5kg or -00136.lb.
4. Net weight > this number always consists of 5 digits, a possible decimal point (as part of the 5 digits), the unit (kg or lb), the positive or negative sign and whether it was a calculated net or a measured net.
For example: +0233.5kgC or -00136.lb_. The 'C' stands for calculated and is sent along when a preset tare value was active. If there is no preset tare value active a blanc (space) is put behind the kg (or lb).
5. Tare weight > this number always consists of 5 digits, a possible decimal point (as part of the 5 digits), the unit (kg or lb), the positive or negative sign and whether it was a preset tare or a measured tare.
For example: +0233.5kgP or -00136.lb_. The 'P' stands for preset tare and is sent along when a preset tare value was active. If there is no preset tare value active a blanc (space) is put behind the kg (or lb).
6. Code > this is the 5-digit code that can be entered by keying in. If no code is activated it will show '0'.
7. Alibi number > this is a 4 digit number which is generated by the indicator itself. It will start at '0001' and increase with every weighing up to '9999'. When this number is reached it will start at '0001' again.

The alibi memory is 1Mbit big. It can contain about 7000 weighings. The alibi memory works with FIFO (first in first out). When it becomes full the oldest data will be first overwritten.

For reading out the data saved in the alibi memory please follow next steps:

1

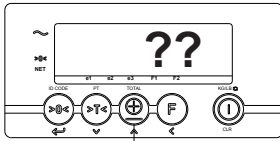

The user menu can be entered by pressing the TOTAL key for at least 10 sec.

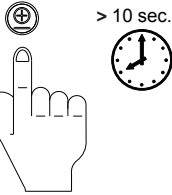

2

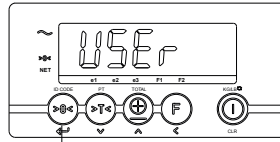

Press enter to Select.



3

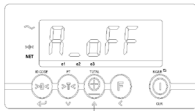

Press the up /down key until the display shows the user setting 'ALibi'.



4

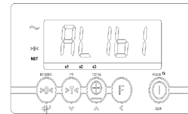

Press enter to confirm.



5

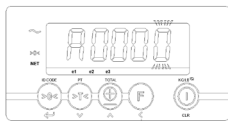

Enter the requested alibi number by using the up and down keys and the shift key. In this example we enter alibi number 2'.



6

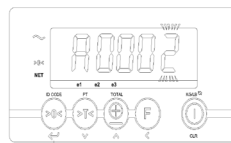

Press enter to confirm.



7

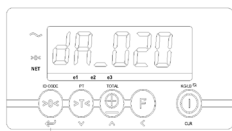

The display now shows the date (first day, then month and year) and the time (first hours, then minutes) of the weighing with alibi number 02.

Press enter to continue to the month.

8

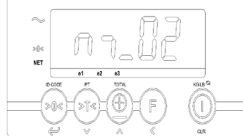

Press enter to continue to the year.

9



Press enter to continue to the hour.

10

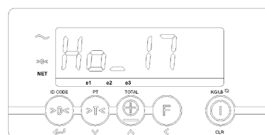

Press enter to continue to the minute.

11

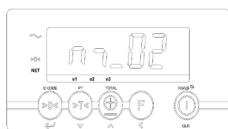

Press enter to continue.

12

For 0,5 sec the display shows the text 'Gross'.
Next the display shows the gross weight.

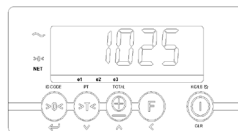

Press enter to continue.

13

For 0,5 sec the display shows the text 'Net' or 'Net_C'.
Next the display shows the net weight.
Net: weight is measured.
Net_C: weight is calculated.

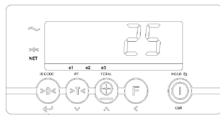

Press enter
to continue.



14

For 0,5 sec the display shows the text 'tArE' or 'PtArE'.
Next the display shows the tare weight.
tare: weight is measured.
Ptare: weight is keyed in.

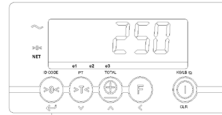

Press enter
to continue.



15

For 0,5 sec the display shows the text 'Code'.
Next the display shows the code used. If
no code was used the display shows '0'.

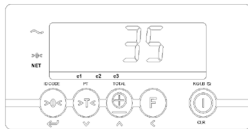

The indicator will automatically
return to the user setting 'Alibi'
in the user menu.



16

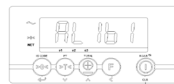

Press enter to search for another
weighing or press 'CLR' 2x to return to
the normal weighing mode.



6. RAVAS WeightsApp - applicable for the iForks-32 (XT)

With the RAVAS WeightsApp you can read the data from your mobile weighing system directly from your smartphone or tablet.

The app not only displays the weight in large digits on a smartphone or tablet, it also stores the weighed gross weights, tare weight, product code, date & time and the ID of the device or operator. The data can be sent to any email address as a CSV file, after which it can be imported in a spreadsheet program on a PC.



From the app you can:

- enter the ID of an operator or device
- enter tares (automatically or manually)
- zero the weighing system

Date and time are automatically generated. If your Android device has an integrated barcode scanner, you can use it to enter product IDs.

In addition the app makes it possible to download a log file from the RAVAS indicator and send it for technical analysis as a CSV file in the event of malfunction.

The RAVAS WeightsApp can be downloaded for free from Google Play and the Apple Store.

For instructions for the use of the RAVAS WeightsApp see www.ravas.com.